

WARIANT

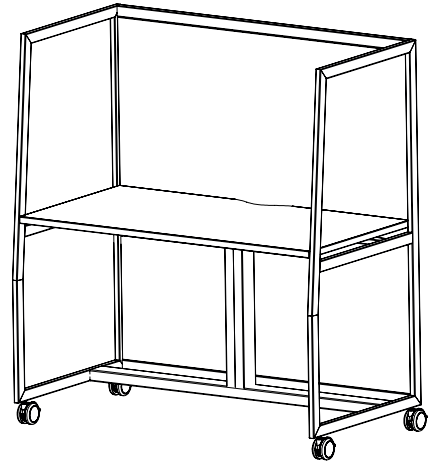
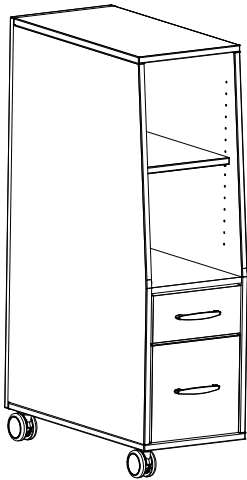

TECHNICAL DESCRIPTION:

MATERIAL AND CONSTRUCTION

- High-quality class E1 MFC - coated on both sides with increased durability melamine;
- Side edges finished with a plastic edging 2 mm thick and rounding r=3 mm;
- Steel, self-supporting racks, consisting of screwed and welded elements;
- Castors Ø75 mm with grey MARO logo and red brake. Castors Ø50 mm with black brake ONLY to compact desks;
- Color range dedicated to the whole WARIANT collection;

DESK WITH LOW MODESTY PANEL

- Tops 25 mm thick;
- Modesty panel made of MFC only;
- Ergonomic outlet as a STANDARD;
- Cable duct as an OPTION;
- Top height ±5 mm tolerance;

DESK WITH HIGH MODESTY PANEL

- Tops 25 mm thick;
- Modesty panel made of MFC or upholstered surface PIN6 – front view;
- Upholstered panels on side walls PIN3 as an OPTION;
- Lower-side panel excludes side desk cabinet;
- Ergonomic outlet as a STANDARD;
- Cable duct as an OPTION;
- Electric height adjustable desks controlled by PLUS panels. PREMIUM control panel as an OPTION;
- Electric height adjustable desks have an anti-collision system as a STANDARD;
- Desks with electric height adjustment are equipped with a plug as STANDARD. Battery as independent source of energy as an OPTION;
- Top height ±5 mm tolerance;

COMPACT DESKS

- Tops 25 mm thick as STANDARD, 18 mm thick as an OPTION;
- When choosing an 18 mm thick top, the height of the desk will always be 7 mm lower;
- Desk with a tilting top, with a special 19 mm thick board, can serve as a dry-wipe board - as an OPTION;
- Ergonomic outlet as an OPTION;
- Upholstered screens PIN6 as an OPTION;
- Screens 30 mm thick, mounted with angle brackets directly to the top of the desk:

- Desk width 900 mm - screen 780 mm;
- Desk width 1000 mm - screen 980 mm;
- Desk width 1200 mm - screen 1180 mm;

- Screens cannot be mounted to desks with tilting tops;
- Desks with electric height adjustment are equipped with a plug as STANDARD. Battery as independent source of energy as an OPTION;
- Top height ±5 mm tolerance;

WARIANT

K-eM LITE MOBILE DESK

- Tops made of 25 mm thick MFC as STANDARD (18 mm as an OPTION at no extra charge. Desks lower by 7mm);

SIDE DESK CABINETS

- Cabinet carcasses are factory-glued , assembled and delivered as a whole;
- Back wall 18 mm thick, plug-mounted, double-sided covered with melamine in the color from MARO's palette.
- Carcass with 18 mm thick upper tie beam;
- 18 mm thick panel shelves. Construction shelves (marked with letter 'k') are permanently mounted;
- Cabinet are mounted directly to the desks (only high modesty panel units);
- Due to the way of assembling, the shelves have only two castors;
- Drawers, as a standard, have handles from MARO B1 and C1 collection with 128 mm spacing. Handles F1, Z1 and W1 - as an OPTION;
- Drawers with SOFT CLOSE AUTOMATIC mechanism with a drawer braking function and automatic closing;
- All drawers have a safety system against simultaneous opening and a central lock;
- 120 mm deep container on top of the cabinet, instead of the top tie beam as an OPTION;

MODULAR CABINETS

- Cabinet bodies are factory glued, assembled and delivered as a whole;
- Each element of the cabinets is characterized by the fact that there is always horizontal graining;
- Cabinets on mobile base with castors or on stationary base with 10 mm adjustable feet. Bases are mounted directly to the bottom tie beam;
- The cabinets can be freely moved and positioned. A maximum of 4 cabinets can be stacked;
- Cabinets can be stacked independently, front – back;
- Upholstered panel PIN6 fixed to the back of the module - as OPTION;
- Hinged doors are equipped with 110° hinges with soft-closing mechanism;
- Drawers as standard have handles from the MARO B1 and C1 collection with 128 mm spacing. Handles F1, Z1 and W1 - as an OPTION;
- Drawers have with SOFT CLOSE AUTOMATIC mechanism with a function of drawer braking and automatic closing;
- A lock for each modular cabinet - as an OPTION;

MOBILE WALL

- Equipped with a 1250 mm high whiteboard (width depending on the product size);
- Rear part of the board covered with upholstery with PIN6 function (only on the dry-wipe area);

MEETING PLACE

- Panel elements 18 mm thick (19 mm thick whiteboard);
- Worktop 1980 mm x 800 mm;
- Four under-counter shelves for office accessories;
- 800 mm x 920 mm whiteboard on the top side;
- 10 mm thick, 880 mm x 1190 mm PIN6 upholstered panels are mounted on the outside as a STANDARD;
- PIN6 panel can be exchanged for whiteboard as an OPTION;

TV STAND

- Cabinet at the bottom 1360 mm x 380 mm. The cabinet has PUSH TO OPEN hinged doors are equipped with 110° hinges with soft-closing mechanism;
- TV mounting bracket included. Hole spacing according to VESA standard;
- TV set max display size 55 inches;

MOBILE ASSISTANT

- Dedicated hook for bag / backpack as standard;
- Panel elements 18 mm and 25 mm thick;

MOBILE WARDROBE

- Panel elements 18 mm thick;
- Upholstered shelf pad - as an OPTION;
- Hangers bar – 450mm;

ACCESSORIES:

- The organizers are dedicated to mobile desks with high modesty panels.
- Can be painted in 8 colors: M01, M02, M04, M05, M06, M07, M08, M09;
- Possibility of cutting out a logo, after prior arrangement of details - as an OPTION;
- Possibility of purchasing a powerbank XTORM with a dedicated under-counter holder.

WARIANT

| | COLOR | | MFC ELEMENTS | | UPHOLSTERED ELEMENTS | FRAME | COLUMN | FOOT | |
|------------------------|----------------|------------------|-------------------|-------------|----------------------|-------|--------|------|---|
| | | | BOARD 25 mm | BOARD 18 mm | | | | | |
| | | | | | | | | | |
| BOARD | GROUP 1 | White | U1 | ● | ● | — | — | — | |
| | | Grey | U2 | ● | ● | — | — | — | |
| | | Grey Platinum | U6 | ● | ● | — | — | — | |
| | | Beige Cashmere | U10 | ● | ● | — | — | — | |
| | | Graphite | U11 | ● | ● | — | — | — | |
| | | Light Maple | D7 | ● | ● | — | — | — | |
| | | Acacia | D11 | ● | ● | — | — | — | |
| | | Napolitano Oak | D3 | ● | ● | — | — | — | |
| | | Beech | D2 | ● | ● | — | — | — | |
| | | American Oak | D12 | ● | ● | — | — | — | |
| | | Havana Cherry | D1 | ● | ● | — | — | — | |
| | | Maroni Walnut | D10 | ● | ● | — | — | — | |
| | | GROUP 2* | Grey Mountain Oak | DR4 | — | ● | — | — | — |
| | | | Madison Walnut | DR1 | — | ● | — | — | — |
| Fumo Chestnut | DR2 | | — | ● | — | — | — | | |
| | | Dry-wipe board** | | — | ● | — | — | — | |
| METAL | GROUP 1 | White | M02 | — | — | — | ● | ● | |
| | | Aluminium | M01 | — | — | — | ● | — | |
| | | Graphite | M05 | — | — | — | ● | — | |
| | | Black | M04 | — | — | — | ● | ● | |
| | GROUP 2* | Sunny Beige | M06 | — | — | — | ● | — | |
| | | Faded Turquoise | M07 | — | — | — | ● | — | |
| | | Ginger | M08 | — | — | — | ● | — | |
| | | Dirty Pink | M09 | — | — | — | ● | — | |
| | | | | | | | | | |
| FABRIC | GROUP 1 | Red | S10 | — | — | ● | — | — | |
| | | Grey | S02 | — | — | ● | — | — | |
| | | Blue | S06 | — | — | ● | — | — | |
| | GROUP 2* | Mixed Red | S11 | — | — | ● | — | — | |
| | | Mixed Blue | S12 | — | — | ● | — | — | |
| | | Mixed Turquoise | S13 | — | — | ● | — | — | |
| | | Lime Green | S14 | — | — | ● | — | — | |
| | | Olive | S15 | — | — | ● | — | — | |
| | | Cappuccino | S16 | — | — | ● | — | — | |
| | | Navy Blue | S17 | — | — | ● | — | — | |
| | | Mixed Grey | S18 | — | — | ● | — | — | |
| | | Black | S19 | — | — | ● | — | — | |
| | | Burgundy | S20 | — | — | ● | — | — | |
| | | Straw Yellow | S21 | — | — | ● | — | — | |
| | Teal | S22 | — | — | ● | — | — | | |
| | Alabaster Grey | S23 | — | — | ● | — | — | | |
| | GROUP 3* | Teal Channel | S102 | — | — | ● | — | — | |
| Teal Chevron | | S202 | — | — | ● | — | — | | |
| Alabaster Grey Channel | | S103 | — | — | ● | — | — | | |
| Alabaster Grey Chevron | | S203 | — | — | ● | — | — | | |

Other board colors from the collection: www.PFLEIDERER.com
 Other metal colors according to RAL palette
 Other fabrics from collection: www.CAMIRAFABRICS.com

* Extra charge for a board from the 2nd color group (+7%); Extra charge for metal from the 2nd color group (+5%);

** As a standard to mobile screens and also as an OPTION to the compact desk WH. NOTE: This board is 19mm thick.

WARIANT DESKS

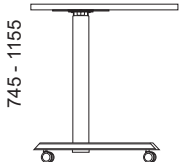
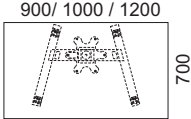
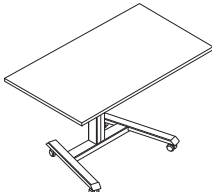
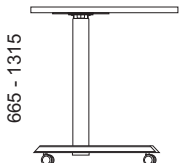
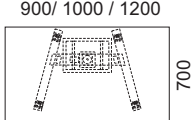
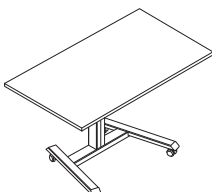
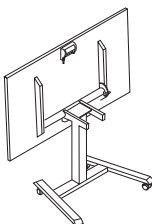
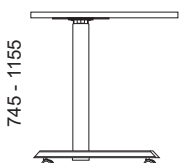
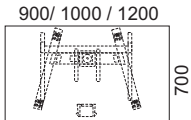
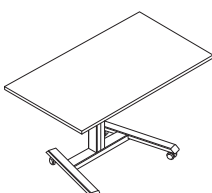
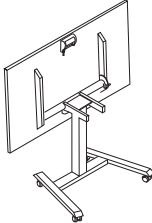
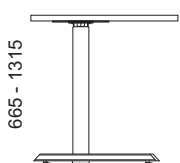
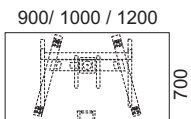
| | DIMENSIONS | | | CODE | NET PRICE |
|---|------------|-------|------------|--------------|-----------|
| | W. mm | D. mm | H. mm | | |
| 1. Compact desk with pneumatic height adjustment | | | | | |
|    | 900 | 700 | 745 - 1155 | WH 01 | |
| | 1000 | 700 | 745 - 1155 | WH 02 | |
| | 1200 | 700 | 745 - 1155 | WH 03 | |
| 2. Compact desk with electric height adjustment | | | | | |
|    | 900 | 700 | 665-1315 | WH 04 | |
| | 1000 | 700 | 665-1315 | WH 05 | |
| | 1200 | 700 | 665-1315 | WH 06 | |
| 3. Compact desk with pneumatic height adjustment and tilting top | | | | | |
|     | 900 | 700 | 745-1155 | WH 07 | |
| | 1000 | 700 | 745-1155 | WH 08 | |
| | 1200 | 700 | 745-1155 | WH 09 | |
| 4. Compact desk with electric height adjustment and tilting top | | | | | |
|     | 900 | 700 | 665-1315 | WH 10 | |
| | 1000 | 700 | 665-1315 | WH 11 | |
| | 1200 | 700 | 665-1315 | WH 12 | |

WARIANT DESKS

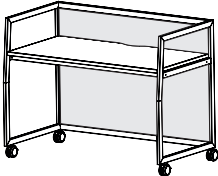
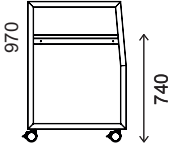
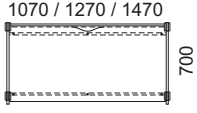
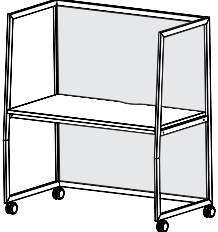
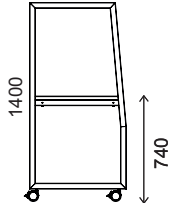
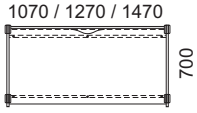
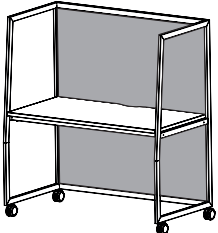
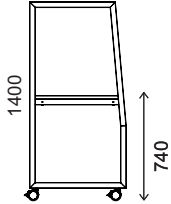
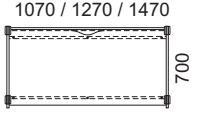
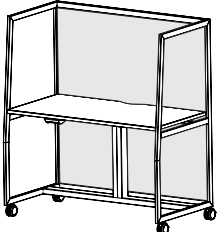
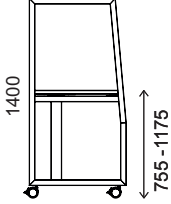
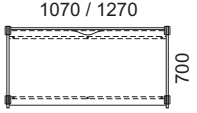
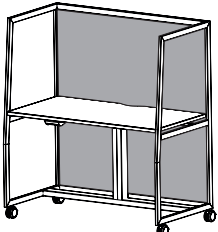
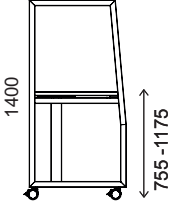
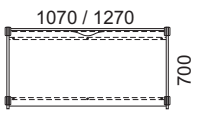
| | DIMENSIONS | | | CODE | NET PRICE | | | | | | | | | |
|---|------------|---------|-------|--------------|--|------------|--|--|-------|--------|---------|--|--|--|
| | W. mm | D. mm | H. mm | | | | | | | | | | | |
| 5. Desk with low modesty panel    | 1070 | 700 | 970 | WI 01 | | | | | | | | | | |
| | 1270 | 700 | 970 | WI 02 | | | | | | | | | | |
| | 1470 | 700 | 970 | WI 03 | | | | | | | | | | |
| 6. Desk with high modesty panel - MFC panel    | 1070 | 700 | 1400 | WA 05 | | | | | | | | | | |
| | 1270 | 700 | 1400 | WA 06 | | | | | | | | | | |
| | 1470 | 700 | 1400 | WA 07 | | | | | | | | | | |
| 7. Desk with high modesty panel - panel upholstered from the inside    | 1070 | 700 | 1400 | WA 08 | <table border="1"> <thead> <tr> <th colspan="3">UPHOLSTERY</th> </tr> <tr> <th>Gr. I</th> <th>Gr. II</th> <th>Gr. III</th> </tr> </thead> <tbody> <tr> <td></td> <td></td> <td></td> </tr> </tbody> </table> | UPHOLSTERY | | | Gr. I | Gr. II | Gr. III | | | |
| UPHOLSTERY | | | | | | | | | | | | | | |
| Gr. I | Gr. II | Gr. III | | | | | | | | | | | | |
| | | | | | | | | | | | | | | |
| | 1270 | 700 | 1400 | WA 09 | | | | | | | | | | |
| | 1470 | 700 | 1400 | WA 10 | | | | | | | | | | |
| 8. Desk with high modesty panel and pneumatic height adjustment - MFC panel    | 1070 | 700 | 1400 | WA 01 | | | | | | | | | | |
| | 1270 | 700 | 1400 | WA 02 | | | | | | | | | | |
| 9. Desk with high modesty panel and pneumatic height adjustment - panel upholstered from the inside    | 1070 | 700 | 1400 | WA 03 | <table border="1"> <thead> <tr> <th colspan="3">UPHOLSTERY</th> </tr> <tr> <th>Gr. I</th> <th>Gr. II</th> <th>Gr. III</th> </tr> </thead> <tbody> <tr> <td></td> <td></td> <td></td> </tr> </tbody> </table> | UPHOLSTERY | | | Gr. I | Gr. II | Gr. III | | | |
| UPHOLSTERY | | | | | | | | | | | | | | |
| Gr. I | Gr. II | Gr. III | | | | | | | | | | | | |
| | | | | | | | | | | | | | | |
| | 1270 | 700 | 1400 | WA 04 | | | | | | | | | | |

WARIANT DESKS

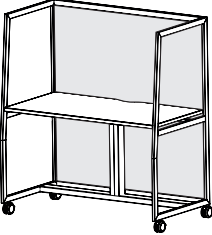
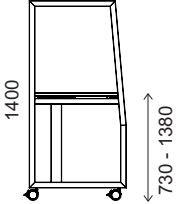
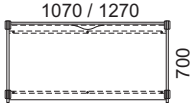
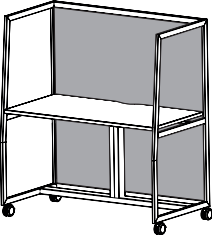
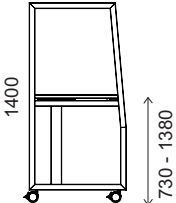
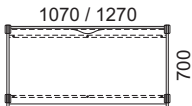
| | DIMENSIONS | | | CODE | NET PRICE | | |
|---|------------|-------|-------|--------------|------------|--------|---------|
| | W. mm | D. mm | H. mm | | | | |
| 10. Desk with high modesty panel and electric height adjustment - MFC panel | | | | | | | |
|    | 1070 | 700 | 1400 | WA 11 | | | |
| | 1270 | 700 | 1400 | WA 12 | | | |
| 11. Desk with high modesty panel and electric height adjustment - panel upholstered from the inside | | | | | | | |
|    | 1070 | 700 | 1400 | WA 13 | UPHOLSTERY | | |
| | 1270 | 700 | 1400 | WA 14 | Gr. I | Gr. II | Gr. III |

WARIANT DESKS

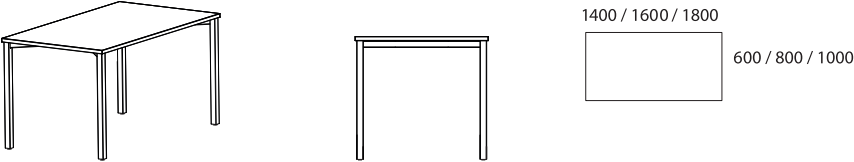
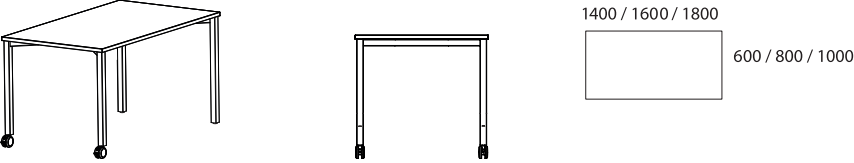
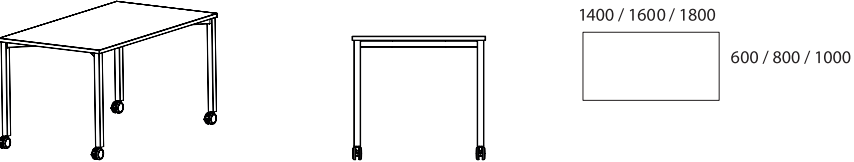
| | DIMENSIONS | | | CODE | NET PRICE |
|---|------------|-------|-------|---------------|-----------|
| | W. mm | D. mm | H. mm | | |
| 12. K-em Lite desk | | | | | |
|  | 1400 | 600 | 740 | WKL 01 | |
| | 1600 | 600 | 740 | WKL 02 | |
| | 1800 | 600 | 740 | WKL 03 | |
| | 1400 | 800 | 740 | WKL 10 | |
| | 1600 | 800 | 740 | WKL 11 | |
| | 1800 | 800 | 740 | WK 12 | |
| | 1400 | 1000 | 740 | WKL 19 | |
| | 1600 | 1000 | 740 | WKL 20 | |
| | 1800 | 1000 | 740 | WKL 21 | |
| 13. K-em Lite Mobile desk, castors with a brake - 2 pcs | | | | | |
|  | 1400 | 600 | 740 | WKL 04 | |
| | 1600 | 600 | 740 | WKL 05 | |
| | 1800 | 600 | 740 | WKL 06 | |
| | 1400 | 800 | 740 | WKL 13 | |
| | 1600 | 800 | 740 | WKL 14 | |
| | 1800 | 800 | 740 | WKL 15 | |
| | 1400 | 1000 | 740 | WKL 22 | |
| | 1600 | 1000 | 740 | WKL 23 | |
| | 1800 | 1000 | 740 | WKL 24 | |
| 14. K-em Lite Mobile desk, castors with a brake - 4 pcs | | | | | |
|  | 1400 | 600 | 740 | WKL 07 | |
| | 1600 | 600 | 740 | WKL 08 | |
| | 1800 | 600 | 740 | WKL 09 | |
| | 1400 | 800 | 740 | WKL 16 | |
| | 1600 | 800 | 740 | WKL 17 | |
| | 1800 | 800 | 740 | WKL 18 | |
| | 1400 | 1000 | 740 | WKL 25 | |
| | 1600 | 1000 | 740 | WKL 26 | |
| | 1800 | 1000 | 740 | WKL 27 | |

WARIANT

SIDE DESK CABINETS

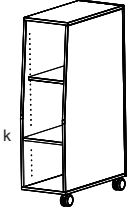
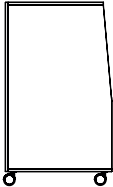
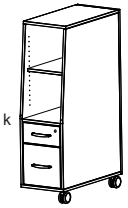
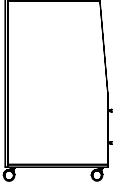
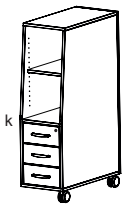
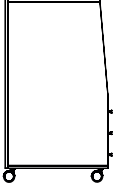
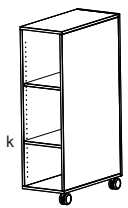
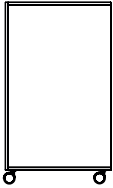
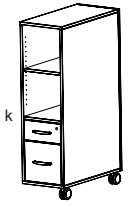
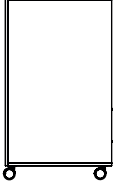
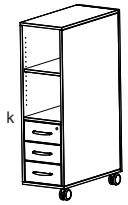
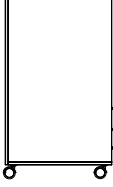
| CABINETS FOR DESK WITH HIGH PANEL | DIMENSIONS | | | CODE | NET PRICE |
|---|------------|----------|----------|--------------|-----------|
| | W. mm | D. mm | H. mm | | |
| 1. Side desk cabinet - open   | 328 | 700 | 1169 | WF 01 | |
| 2. Side desk cabinet - with two drawers   | 328 | 700 | 1169 | WF 02 | |
| 3. Side desk cabinet - with three drawers   | 328 | 700 | 1169 | WF 03 | |
| 4. Rectangular side desk cabinet - open   | 328 | 700 | 1169 | WF 04 | |
| 5. Rectangular side desk cabinet - with two drawers   | 328 | 700 | 1169 | WF 05 | |
| 6. Rectangular side desk cabinet - with three drawers   | 328 | 700 | 1169 | WF 06 | |

k- construction shelf.

*Looking at the side of the high modesty panles, cabinets 1-3 fit perfectly to the desk frame.

WARIANT

SIDE DESK CABINETS

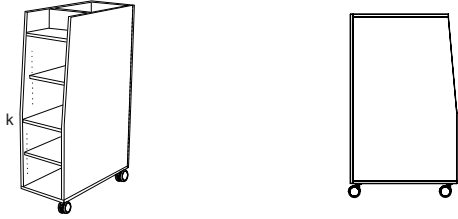
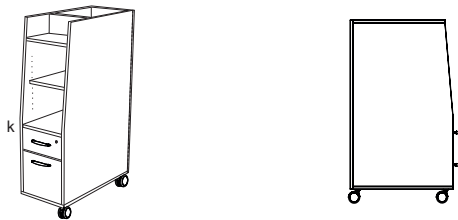
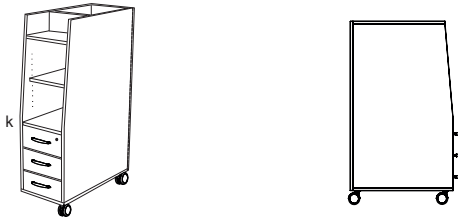
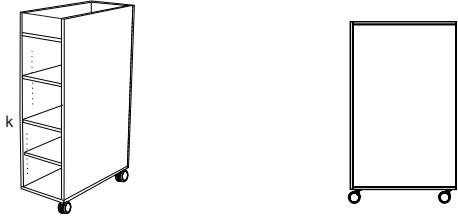
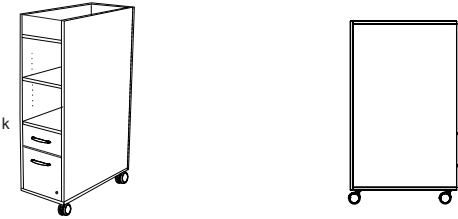
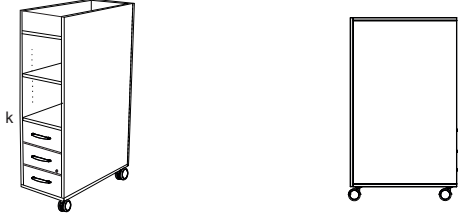
| CABINETS FOR DESK WITH HIGH PANEL | DIMENSIONS | | | CODE | NET PRICE |
|---|------------|----------|----------|--------------|-----------|
| | W. mm | D. mm | H. mm | | |
| 7. Side desk cabinet - open, with plant space*  | 328 | 700 | 1169 | WF 07 | |
| 8. Side desk cabinet - with two drawers and plant space*  | 328 | 700 | 1169 | WF 08 | |
| 9. Side desk cabinet - with three drawers and plant space*  | 328 | 700 | 1169 | WF 09 | |
| 10. Rectangular side desk cabinet - open, with plant space*  | 328 | 700 | 1169 | WF 10 | |
| 11. Rectangular side desk cabinet - with two drawers and plant space*  | 328 | 700 | 1169 | WF 11 | |
| 12. Rectangular side desk cabinet - with three drawers and plant space*  | 328 | 700 | 1169 | WF 12 | |

k- construction shelf.

*The plant space is not waterproof.

**Looking at the side of the high modesty panles, cabinets 7-9 fit perfectly to the desk frame.

WARIANT

MODULE CABINETS

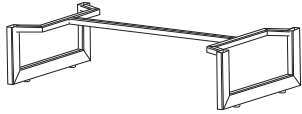
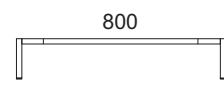
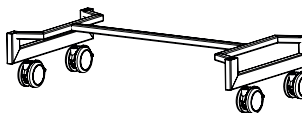
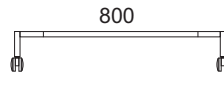
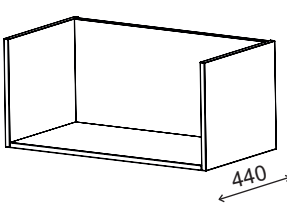
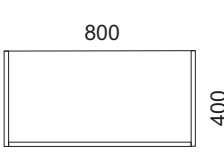
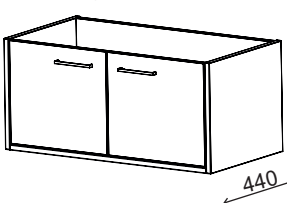
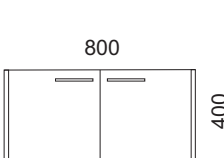
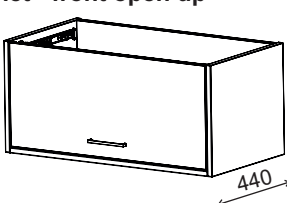
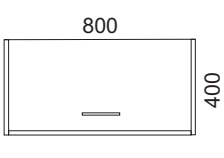
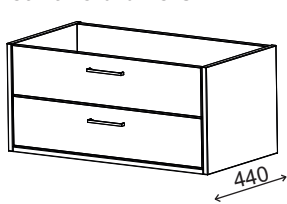
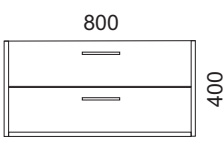
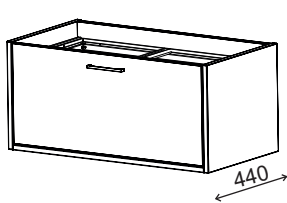
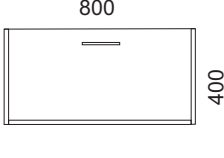
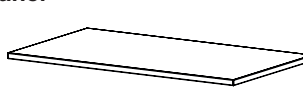
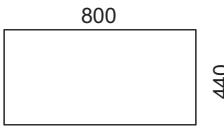
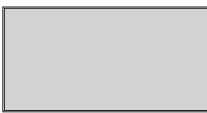
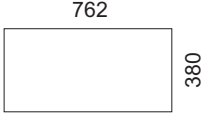

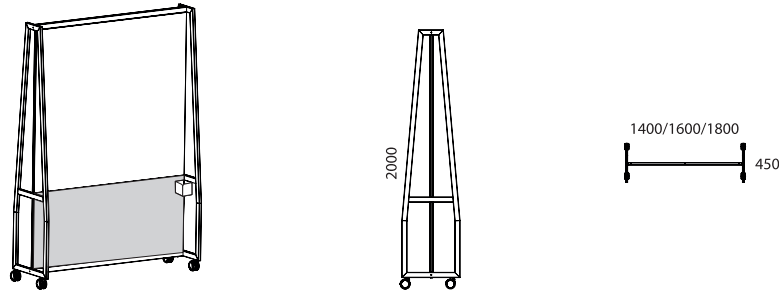
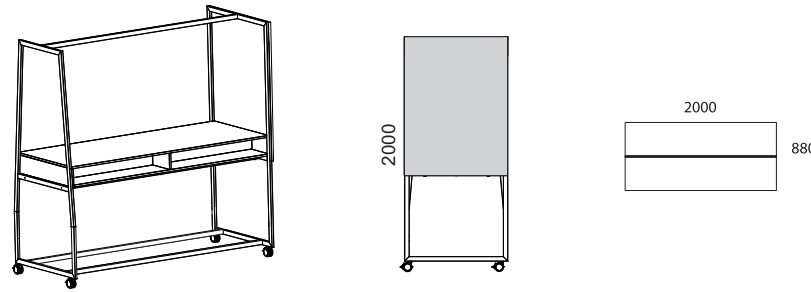
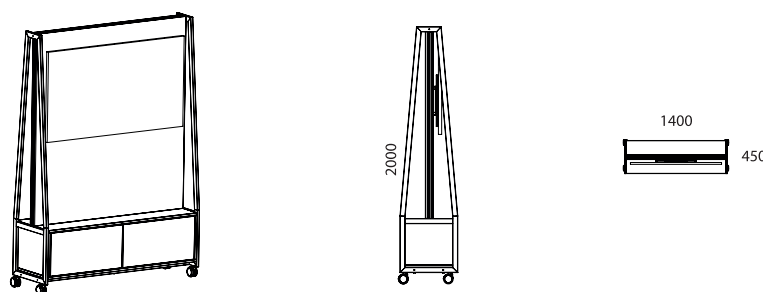
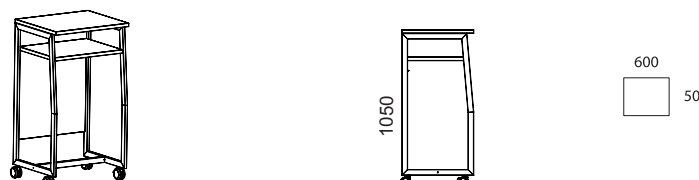
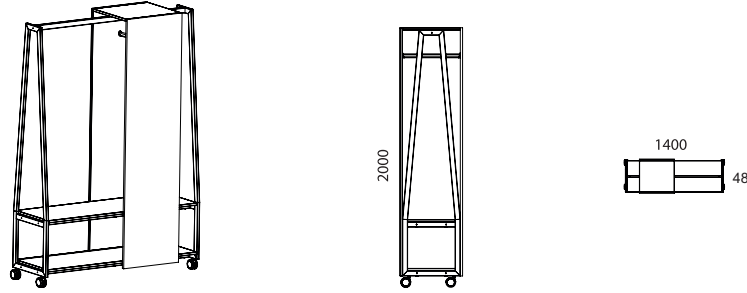

| 1. Base | CODE | NET PRICE | | | | | | |
|---|--------------|---|-------|--------|---------|--|--|--|
| stationery base   | WM 09 | | | | | | | |
| Mobile base   | WM 10 | | | | | | | |
| 2. Module cabinet - open   | WM 01 | | | | | | | |
| 3. Module cabinet - hinged door   | WM 02 | | | | | | | |
| 4. Module cabinet - front open up   | WM 03 | | | | | | | |
| 5. Module cabinet - two drawers   | WM 04 | | | | | | | |
| 6. Module cabinet - registry drawer   | WM 05 | | | | | | | |
| 7. Upper tie panel   | WM 06 | | | | | | | |
| 8. Upholstered panel to the rear of the module   | WM 08 | UPHOLSTERY <table border="1" style="width: 100%; border-collapse: collapse;"> <thead> <tr> <th style="width: 33%;">Gr. I</th> <th style="width: 33%;">Gr. II</th> <th style="width: 33%;">Gr. III</th> </tr> </thead> <tbody> <tr> <td style="height: 40px;"></td> <td style="height: 40px;"></td> <td style="height: 40px;"></td> </tr> </tbody> </table> | Gr. I | Gr. II | Gr. III | | | |
| Gr. I | Gr. II | Gr. III | | | | | | |
| | | | | | | | | |

WARIANT

COMPLIMENTARY FURNITURE

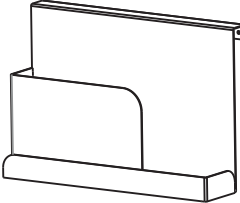
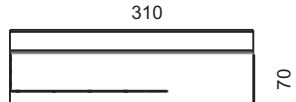
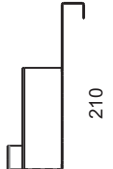
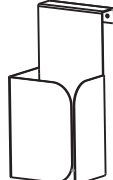
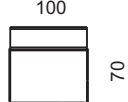
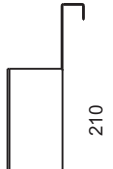
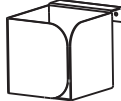
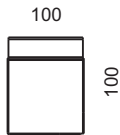
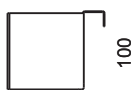
| | DIMENSIONS | | | CODE | NET PRICE | | |
|---|------------|-------|-------|--------------|-----------|--------|---------|
| | W. mm | D. mm | H. mm | | Gr. I | Gr. II | Gr. III |
| 1. Mobile screen  <p>Horizontal or vertical stitching on the fabric in the third price group, to be selected by the customer</p> | 1400 | 450 | 2000 | WW 01 | | | |
| | 1600 | 450 | 2000 | WW 02 | | | |
| | 1800 | 450 | 2000 | WW 03 | | | |
| 2. Meeting place  | 2000 | 880 | 2000 | WU 01 | | | |
| | | | | | | | |
| 3. TV stand  | 1400 | 450 | 2000 | WV 01 | | | |
| | | | | | | | |
| 4. Mobile assistant  | 600 | 500 | 1050 | WO 01 | | | |
| | | | | | | | |
| 5. Mobile wardrobe  | 1400 | 485 | 2000 | WY 01 | | | |
| | | | | | | | |

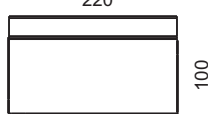

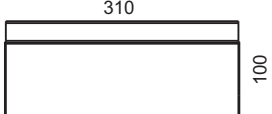
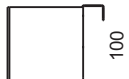

WARIANT ACCESSORIES

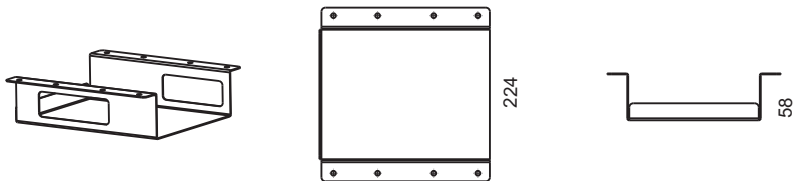
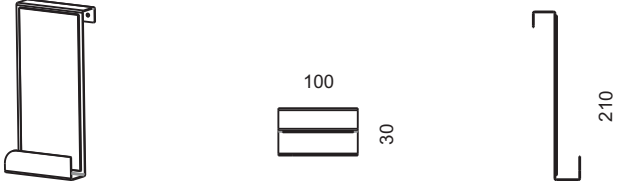
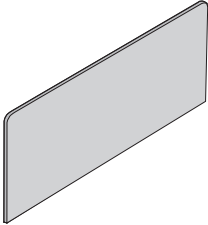
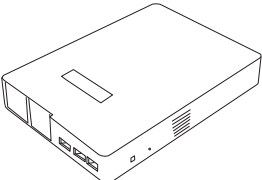
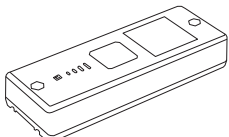
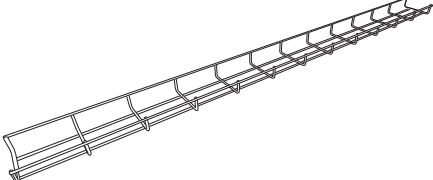
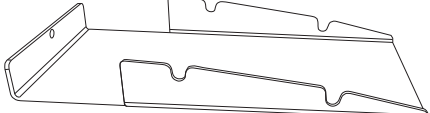
| | DIMENSIONS | | | CODE | NET PRICE |
|---|------------|-------|-------|--------------|-----------|
| | W. mm | D. mm | H. mm | | |
| 1. Organizer 01    | 310 | 70 | 210 | WX 01 | |
| 2. Organizer 02    | 100 | 70 | 210 | WX 02 | |
| 3. Organizer 03    | 100 | 100 | 100 | WX 03 | |
| 4. Organizer 04    | 220 | 100 | 30 | WX 04 | |
| 5. Organizer 05    | 310 | 100 | 100 | WX 05 | |

WARIANT ACCESSORIES

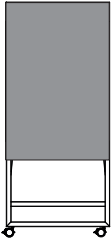
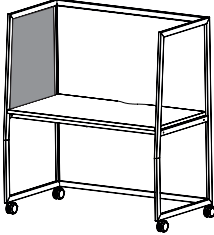
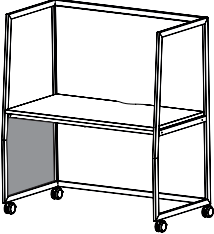
| | DIMENSIONS | | | CODE | NET PRICE |
|--|------------|-------|-------|--------------|--|
| | W. mm | D. mm | H. mm | | |
| 6. Organizer 06 - X-Torm power bank holder  | 162 | 224 | 58 | WX 06 | |
| 7. Organizer 07 - mirror  | 100 | 30 | 210 | WX 07 | |
| 8. Upholstered partition for compact desks  | 780 | 30 | 500 | UY 71 | UPHOLSTERY Gr. I Gr. II Gr. III |
| | 980 | 30 | 500 | UY 72 | |
| | 1180 | 30 | 500 | UY 73 | |
| | | | | | |
| 9. X-Torm power bank <ul style="list-style-type: none"> • battery capacity: 41,600 mAh • battery type: Lithium Ion • sizes: 22,2 x 16 x 5,2 cm • input: DC 24V / 2A • output: 2x USB 5V / 3,4A, 1x USB-C 5V / 3,1A, 2x 230AC (200 W) • weight: 1400 g • thermal protection, overcurrent protection  | 222 | 160 | 52 | WX 11 | |
| 10. Battery for compact desks <ul style="list-style-type: none"> • rechargeable Li- ion battery cells • battery alarm (audio) when charging is needed • battery charging indicator (LED light bars) indicating the capacity levelbattery • thermal switch protection, overcurrent protection • color: black • battery capacity: 2,15 Ah / 52 Wh • nominal voltage: 24 V DC • weight: 600 g  | - | - | - | WX 12 | |
| 11. Cable channel  | 1020 | | | WX 13 | |
| | 1270 | - | - | | |
| | 1370 | | | | |
| 12. PC Holder for desks with modesty panel and height adjustment  | - | - | - | WX 14 | |

WARIANT SURCHARGE

| | DIMENSIONS | | NET PRICE | | |
|--|-----------------------------|---------------------------|------------|--------|---------|
| | W. mm | D. mm | | | |
| 1. Dry- wipe plate in the top of a compact desk  | 900 1000 1200 | 700 700 700 | | | |
| 2. Dry- wipe plate in the MEETING PLACE  | 880 | 1190 | | | |
| 3. Top side panel  | - | - | UPHOLSTERY | | |
| | | | Gr. I | Gr. II | Gr. III |
| 4. Bottom side panel  | - | - | UPHOLSTERY | | |
| | | | Gr. I | Gr. II | Gr. III |
| 5. Lock for modular cabinets*  | - | - | | | |
| 6. Lock for modular cabinets with two drawers  | - | - | | | |
| 7. Compact desk top with rounded front corners  | - | - | | | |

*Does not apply to modular cabinets with two drawers.

WARIANT SURCHARGE

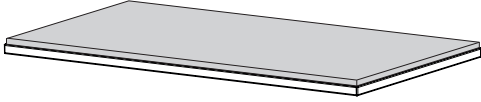
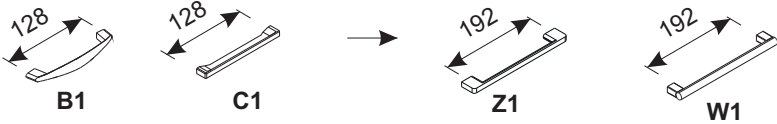
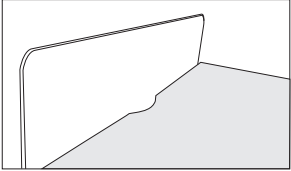
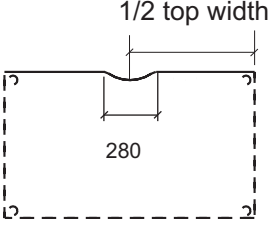
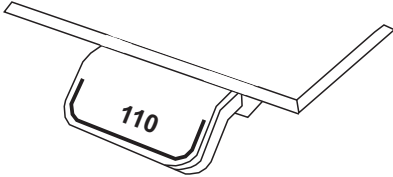
| | NET PRICE | | | | | | |
|--|---|---------|--------|---------|--|--|--|
| <p>8. Upholstered panel to the Mobile wardrobe</p> <div style="text-align: center; margin: 20px 0;">  </div> | UPHOLSTERY <table border="1" style="width: 100%; border-collapse: collapse;"> <thead> <tr> <th style="width: 33%;">Gr. I</th> <th style="width: 33%;">Gr. II</th> <th style="width: 33%;">Gr. III</th> </tr> </thead> <tbody> <tr> <td style="height: 40px;"></td> <td></td> <td></td> </tr> </tbody> </table> | Gr. I | Gr. II | Gr. III | | | |
| Gr. I | Gr. II | Gr. III | | | | | |
| | | | | | | | |
| <p>9. Logo laser cut in accessories</p> | VALUATION INDIVIDUAL | | | | | | |
| <p>10. Handles</p> <div style="text-align: center; margin: 20px 0;">  </div> | | | | | | | |
| <p>11. Ergonomic cable outlet</p> <div style="display: flex; justify-content: space-around; align-items: center; margin: 20px 0;">   </div> | | | | | | | |
| <p>12. PREMIUM control panel</p> <p>Premium control panel is your "digital assistant" that reliably reminds when it's time to get up or sit down. The up and down movement is indicated with a backlit bar on the panel. Thanks to memory function, panel remembers up to 4 favorite heights. The remote control is equipped with a Bluetooth module, allowing to control your desk, using your phone, tablet, or even a computer. The Premium Pilot allows you to get the most out of your desk.</p> |  | | | | | | |