

# New School - tables technical specification



**.mdd**

**.mdd has a leading position among manufacturers of office furniture with many awards that prove quality and continuously increase demand for it's products.**

The realities of today`s market require constant quality improvement at all levels of modern organization. This applies in particular to customer service, marketing, quality of products and also to quality of processes within the company.

Partnership relations among employees and with business partners form a base of economic growth and success of the company.

Constant investments in innovative machinery park, optimization of management systems and an expansion of production halls allow to minimize the lead times for the product of the highest quality.

**More than twenty years of experience in office furniture industry come with reference from a long list of companies and institutions to show their appreciation for an efficient and comprehensive service. .mdd is highly aware of the environment.**

Being located in the forest region with lake by it's side, .mdd takes the nature seriously and invests constantly in a modern and energy-efficient solutions to preserve the local life. Company puts emphasis on waste segregation and recycling. .mdd has been awarded for the exceptional care and involvement in waste disposal. All materials used are environmentally friendly and enjoy a high 95 % rate of being recycled.



## General informations:

### Warranty:

.mdd products - **5 years.**

Electrical components and fabric - **2 years.**

### Certificate - MFC:



### Certificate - linoleum:



### Assembly:

the product comes pre-assembled

### Packing:

cardboard

## Technical specification

1. **Top** - 19 mm MDF board; covered in bacteriostatic linoleum with resistance to finger prints; varnished Edge
2. **Frame** - metal, powder coated, frame made of tube Ø25 mm
3. **Leveling feet** - range 9 mm

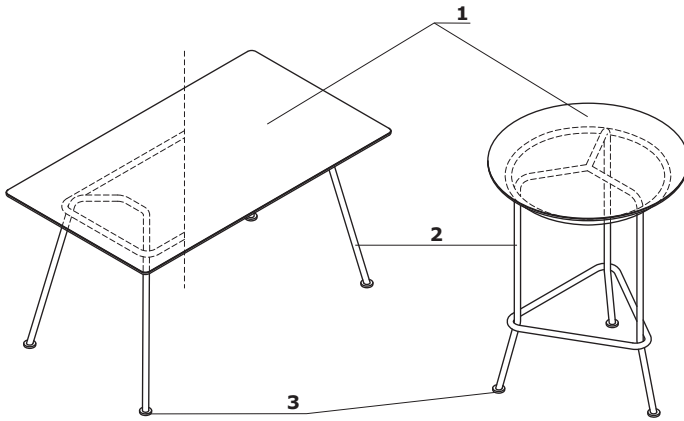

Top edging always matching the colour of the framework.

New School - tables \*



**NS812**  
1200 / 800 / 750  
33.1 kg



**NS814**  
1400 / 800 / 750  
33.5 kg

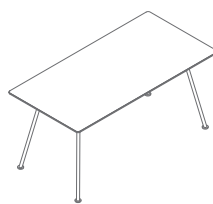

**NS816**  
1600 / 800 / 750  
36.6 kg

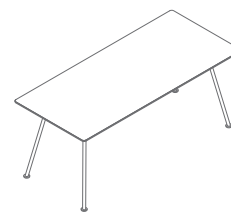

**NS818**  
1800 / 800 / 750  
40.3 kg



**NS77**  
700 / 700 / 750  
19.8 kg



**NS88**  
800 / 800 / 750  
25.3 kg

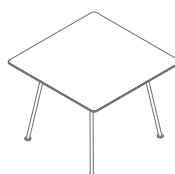

**NS11**  
1000 / 1000 / 750  
31 kg



**NS70**  
700 / 700 / 750  
15.5 kg



**NS80**  
800 / 800 / 750  
17 kg



**NS100**  
1000 / 1000 / 750  
26.5 kg

New School - high tables \*



**NS80H**  
800 / 800 / 1050  
22 kg



**NS100H**  
1000 / 1000 / 1050  
31.7 kg

\* dimensions expressed in millimeters: width x depth x height

New School - high tables \*



**NS88H**  
800 / 800 / 1050  
30.5 kg



**NS11H**  
1000 / 1000 / 1050  
37.5 kg



**NS812H**  
1200 / 800 / 1050  
39.5 kg



**NS814H**  
1400 / 800 / 1050  
40.5 kg



**NS816H**  
1600 / 800 / 1050  
43.8 kg

New School - meeting tables \*

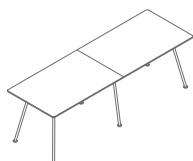

**NS824**  
2400 / 800 / 750  
61.9 kg

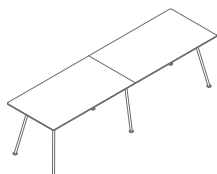

**NS828**  
2800 / 800 / 750  
62.7 kg

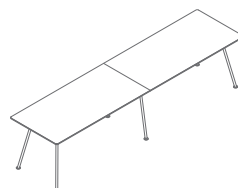

**NS832**  
3200 / 800 / 750  
69.1 kg

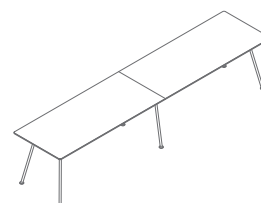

**NS836**  
3600 / 800 / 750  
76.1 kg

\* dimensions expressed in millimeters: width x depth x height

**Worktop - Linoleum**



Light grey



Dark green



Burgundy



Black



Blue

**Frame - metal**



M012 Dark green  
semi-matt RAL6012



M013 Burgundy  
semi-matt RAL3007



M115 Black  
semi-matt RAL9005



M010 Light grey  
semi-matt RAL7044



M027 Blue  
semi-matt RAL5003